

User Manual

GETTING STARTED? EASY.



ZWT 71201 WA

EN User Manual
Washer Dryer

ZANUSSI

SAFETY INFORMATION

Before the installation and use of the appliance, carefully read the supplied instructions. The manufacturer is not responsible for any injuries or damages that are the result of incorrect installation or usage. Always keep the instructions in a safe and accessible location for future reference.

CHILDREN AND VULNERABLE PEOPLE SAFETY



WARNING!

Risk of suffocation, injury or permanent disability.

- This appliance can be used by children aged from 8 years and above and persons with reduced physical, sensory or mental capabilities or lack of experience and knowledge if they have been given supervision or instruction concerning the use of the appliance in a safe way and understand the hazards involved.
- Children between 3 and 8 years of age and persons with very extensive and complex disabilities shall be kept away unless continuously supervised.
- Children of less than 3 years of age should be kept away unless continuously supervised.
- Do not let children play with the appliance.
- Keep all packaging away from children and dispose of it appropriately.
- Keep detergents away from children.
- Keep children and pets away from the appliance when the door is open.
- If the appliance has a child safety device, it should be activated.
- Children shall not carry out cleaning and user maintenance of the appliance without supervision.

GENERAL SAFETY

- Do not change the specification of this appliance.
- This appliance is intended to be used in household and similar applications such as:
 - staff kitchen areas in shops, offices and other working environments;

- by clients in hotels, motels, bed & breakfast and other residential type environments;
- areas for communal use in blocks of flats or in launderettes.
- The appliance shall be installed as a freestanding product or below the kitchen worktop if space margins permit.
- Do not install the appliance behind a lockable door, a sliding door or a door with a hinge on the opposite side, that would prevent the appliance door from being fully open.
- Connect the mains plug to the mains socket only at the end of the installation process. Make sure that the mains plug is accessible after installation.
- The ventilation opening in the base must not be covered by a carpet, mat, or any floor covering.
- **WARNING:** The appliance must not be supplied through an external switching device, such as a timer, or connected to a circuit that is regularly switched on and off by a utility.
- Ensure good air ventilation in the room where the appliance is installed to avoid the backflow of unwanted gases into the room from appliances burning gas or other fuels, including open fires.
- Exhaust air must not be discharged into a flue which is used for exhausting fumes from any appliances burning gas or other fuels.
- The operating water pressure at the water entry point from the outlet connection must be between 0.5 bar (0.05 MPa) and 8 bar (0.8 MPa).
- Do not exceed the maximum load of 7 kg (refer to the "Programme chart" chapter).
- The appliance must be connected to the water mains using the new supplied hose sets, or other new hose sets supplied by the Authorised Service Centre.
- Old hose sets must not be reused.
- If the mains power supply cable is damaged, it must be replaced by the manufacturer, its Authorised Service Centre or similarly qualified persons to avoid an electrical hazard.
- Wipe away lint or packaging debris that has accumulated around the appliance.

- Items that have been soiled with substances such as vegetable or mineral oil, acetone, alcohol, petrol, kerosene, spot removers, turpentine, waxes and wax removers should be washed separately with an extra amount of detergent before being dried in the washer dryer.
- Do not use the appliance if items have been soiled with industrial chemicals.
- Do not dry unwashed items in the wash dryer.
- Items such as foam rubber (latex foam), shower caps, waterproof textiles, and rubber backed articles and clothes, or pillows fitted with foam rubber pads should not be dried in the washer dryer.
- Fabric softeners, or similar products, should only be used as specified by the product manufacturer's instructions.
- Remove all objects from items that could be a source of fire ignition such as lighters or matches.
- Never stop the washer dryer before the end of the drying cycle unless all items are quickly removed and separated so that residual heat can dissipate.
- The final part of the washer dryer cycle takes place without heat (cool down cycle) to ensure that items reach a temperature that will not cause damage to them.
- Do not use high pressure water sprays and/or steam to clean the appliance.
- Clean the appliance with a moist cloth. Use only neutral detergents. Do not use abrasive products, abrasive cleaning pads, solvents or metal objects.
- Before any maintenance operation, deactivate the appliance and disconnect the mains plug from the socket.

SAFETY INSTRUCTIONS

INSTALLATION



The installation must comply with relevant national regulations.

- Follow the installation instructions supplied with the appliance.
- Do not install or use the appliance where the temperature can be less than 0°C or where it is exposed to the weather.
- Always keep the appliance vertical when it is being moved.
- Make sure that there is air circulation between the appliance and the floor.
- Remove all the packaging and the transit bolts.

- The floor area on which the appliance is to be installed must be flat, stable, heat resistant and clean.
- Keep the transit bolts in a safe place. If the appliance is to be moved in the future they must be reattached to lock the drum to prevent an internal damage.
- Always take care when moving the appliance as it is heavy. Always use safety gloves and enclosed footwear.
- Do not install or use a damaged appliance.
- Do not install the appliance where the appliance door cannot be fully opened.
- Adjust the feet to have the necessary space between the appliance and the flooring.
- When the appliance is in its permanent position, check if it is levelled correctly with the aid of a spirit level. If it is not, adjust the feet accordingly.
- Do not put flammable products or items that are wet with flammable products in, near or on the appliance.
- Do not touch the glass door while a programme is in operation. The glass can get hot.
- Do not dry damaged (torn, frayed) items that contain padding or fillings.
- If laundry has been washed with a stain remover, carry out an additional rinse cycle before starting a drying cycle.
- Make sure that all metal objects are removed from the laundry.
- Only dry fabrics that are suitable to dry in the washer dryer. Follow the cleaning instruction on the item label.
- Plastic items are not heat resistant.
 - If a detergent ball is used, remove it before starting a drying programme.
 - Do not use a detergent ball if setting a non-stop programme.

ELECTRICAL CONNECTION



WARNING! Risk of fire and electric shock.

- The appliance must be earthed.
- Always use a correctly installed shockproof socket.
- Do not use multi-plug adapters and extension cables.
- Do not pull the mains cable to disconnect the appliance. Always pull the mains plug.
- Do not touch the mains cable or the mains plug with wet hands.
- UK and Ireland only. This appliance is fitted with a 13 A mains plug. If it is necessary to change the mains plug fuse, use only a 13 A ASTA (BS 1362) fuse.
- This appliance complies with the E.E.C. Directives.

WATER CONNECTION

- Do not cause damage to the water hoses.
- Before connection to new pipes, pipes not used for a long time, where repair work has been carried out or new devices fitted (water meters, etc.), let the water flow until it is clean and clear.
- Ensure that there are no visible water leaks during and after the first use of the appliance.

USE



WARNING! Risk of injury, electric shock, fire, burns or damage to the appliance.



WARNING! Risk of injury or damage to the appliance.

- Do not sit or stand on the open door.
- Do not dry dripping wet clothes in the appliance.

SERVICE

- To repair the appliance contact an Authorised Service Centre.
- Use original spare parts only.

DISPOSAL

- Disconnect the appliance from the mains electrical and water supplies.
- Cut off the mains electrical cable close to the appliance and dispose of it.
- Remove the door catch to prevent children or pets from becoming trapped in the drum.
- Dispose of the appliance in accordance with local requirements for the disposal of Waste Electrical and Electronic Equipment (WEEE).

PRODUCT DESCRIPTION

APPLIANCE OVERVIEW

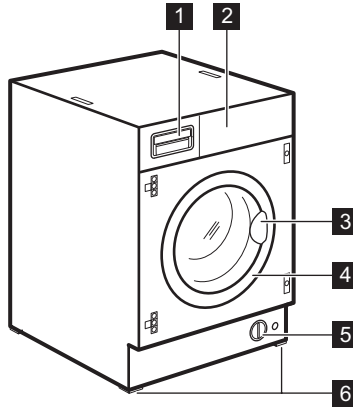

- 1** Detergent dispenser
- 2** Control panel
- 3** Door handle
- 4** Rating plate
- 5** Drain pump filter
- 6** Feet for levelling the appliance

CHILD SAFETY

This device prevents children or pets to be closed in the drum.

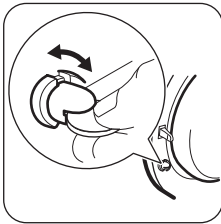

- Turn the device clockwise, until the groove is horizontal. You cannot close the door.
- To close the door, turn the device anti-clockwise until the groove is vertical.

INSTALLATION ON SUSPENDED FLOORING

Suspended wooden floors are particularly susceptible to vibration.

To limit vibration we recommend placing a waterproof wooden panel, at least 15 mm thick, under the appliance. It should be screwed to at least 2 floor beams and should extend beyond the front feet.

If possible, install the appliance where the floor is more stable.

CONTROL PANEL

CONTROL PANEL DESCRIPTION

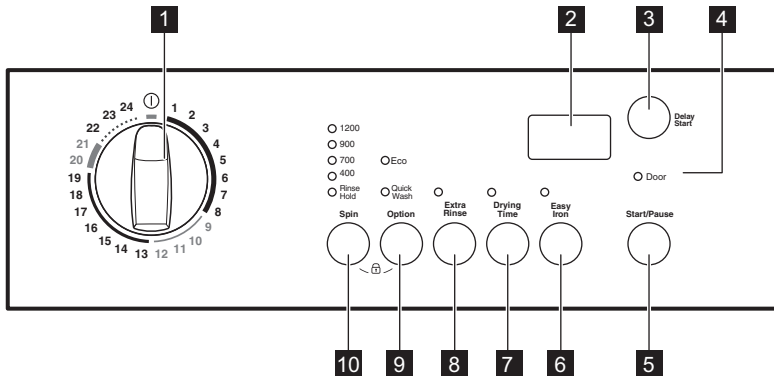

- 1** Programme knob and On/Off position (ⓐ)
- 2** Display
- 3** Delay Start button (Delay Start)
- 4** Door Locked indicator (Door)
- 5** Start/Pause button (Start/Pause)
- 6** Easy Iron button (Easy Iron)
- 7** Drying Time button (Drying Time)
- 8** Extra Rinse button (Extra Rinse)
- 9** Options button (Option)
- 10** Spin Reduction button (Spin)

DISPLAY

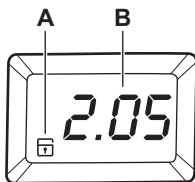

The display shows:

A. Child lock indicator

This device permits you to leave the appliance unattended during its functioning (see «Child Lock» paragraph). The indicator comes when the related option is set.

B. This area shows:

- **Programme time**

After the programme selection, the duration is displayed in hours and minutes (for example 2.10).

The duration is calculated automatically on the basis of the maximum recommended load for each type of fabric.

After the programme start, the time remaining is updated every minute

▪ **Selected drying time**

After selecting a drying programme, the drying time is displayed in minutes or in hours and minutes (e.g. 130 mins = 2.10).

After the programme start, the time remaining is updated every minute.

▪ **End of programme**

When the programme has finished three flashing zeros are displayed.

▪ **Delay start**

When you press the delay start button, the display shows the delay start time.

After the programme start, the set delay appears for few seconds, then the duration of the set programme is displayed again.

- **Alarm codes**

If the appliance has a malfunction, the display shows the alarm codes. Refer to the chapter 'Troubleshooting'.

- **Incorrect option selection**

The display shows the message **Err** for some seconds and the Start/Pause indicator button flashes if :

- You set a option that is not suitable for the programme.
- You change the programme while it operates.

PROGRAMMES

PROGRAMME CHART

	Programme Temperature range	Maximum load Reference spin speed	Programme description (Type of load and soil level)
Washing programmes			
1 - 5	Cottons¹⁾ 90°C - 60°C - 40°C - 30°C - Cold	7 kg 1200 rpm	White cotton and coloured cotton. Normal, heavy and light soil.
6 - 8	Cottons + Prewash 90°C- 60°C - 40°C	7 kg 1200 rpm	White cotton and coloured cotton. Heavy soil and normal soil.
9 - 12	Synthetics 60°C - 40°C - 30°C - Cold	3 kg 900 rpm	Synthetic items or mixed fabric items. Normal soil.
13 - 15	Delicates 40°C - 30°C - Cold	3 kg 700 rpm	Delicate fabrics such as acrylics, viscose and mixed fabrics requir- ing gentler washing. Normal soil.
16	Jeans 40°C	3 kg 1200 rpm	Items in denim and jersey. Also for dark coloured items.
17 - 19	Handwash 40°C - 30°C - Cold	2 kg 900 rpm	Machine washable wool, hand washable wool and other fabrics with «hand washing» care symbol ²⁾ .
	Drying		

	Programme Temperature range	Maximum load Reference spin speed	Programme description (Type of load and soil level)
20	Dry - Cottons	4 kg	Drying programme for cotton items .
21	Dry - Synthetics	2 kg	Drying programme for synthetic items .
	Extra		
22	Rinses	7 kg 1200 rpm	To rinse and spin the laundry. All fabrics , except woollens and very delicate fabrics. Reduce the spin speed accordingly to the type of laundry.
23	Drain	7 kg	To drain the water after programme with the option Rinse Hold set.
24	Spin	7 kg 1200 rpm	To spin and drain the water after programme with the option Rinse Hold set. Set the spin speed according to the fabric to be spun.

1) «The programme Cottons at 60°C with a load of 7 kg, with the option Eco set, is the '«Cottons Energy Saving Programme», reference programme for the data entered in the energy label in compliance with EEC 92/75 standards.

2) During this cycle the drum rotates slowly to ensure a gentle wash. It can seem that the drum doesn't rotate or doesn't rotate properly, but this is normal for this programme.

Programme options compatibility

Programme	Spin	Rinse Hold	Eco	Quick Wash	Extra Rinse	Easy Iron
Cottons	■	■	■	■	■	■
Cottons + Prewash	■	■	■	■	■	■
Synthetics	■	■	■	■	■	■
Delicates		■	■		■	
Jeans	■	■				■
Handwash	■	■				
Rinses	■	■			■	■
Drain	■					
Spin						

PROGRAMMES FOR TIMED DRYING

Dryness Level	Type of fabric	Load (kg)	Spin speed (rpm)	Suggested duration (mins)
Extra Dry For towelling materials	Cottons and Linen (bathrobes, bath towels, etc)	4	1200	215 - 220
		3	1200	160 - 180
		1.5	1200	95 - 105
Cupboard Dry¹⁾ For items to be stored	Cottons and Linen (bathrobes, bath towels, etc)	4	1200	205 - 210
		3	1200	150 - 170
		1.5	1200	85 - 95
Cupboard Dry For items to be stored	Synthetics and mixed fabrics (jumpers, blouses, underwear, household and bed linen)	2	900	90 - 100
		1	900	55 - 65
Iron Dry Suitable for ironing	Cottons and Linen (sheets, tablecloths, shirts, etc)	4	1200	140 - 150
		3	1200	90 - 100
		1.5	1200	60 - 70

1) Hints for test institute. The test performance, in accordance with EN 50229:2015, must be carried out with a FIRST drying load of the maximum declared drying capacity by setting 210 minutes by means of the Drying Time button for the Dry - Cottons programme. The SECOND drying load with the residual load must be tested by setting 130 minutes by means of the Drying Time button for the Dry - Cottons programme.

CONSUMPTION VALUES



Stated values are obtained in laboratory conditions with relevant standards. Different causes can change the data: the quantity and type of laundry and ambient temperature. Water pressure, the supply voltage and the temperature of inlet water may also affect the washing programme duration.



Technical specifications may be changed without prior notice to improve the quality of product.

Programmes	Load (kg)	Energy consumption (kWh)	Water consumption (litre)	Approximate programme duration (minutes)
Cottons 60°C	7	1.35	67	150

Programmes	Load (kg)	Energy consumption (kWh)	Water consumption (litre)	Approximate programme duration (minutes)
Cottons Eco Cotton Energy Saving Programme 60°C ¹⁾	7	1.05	55	220
Cottons 40°C	7	0.85	67	140
Synthetics 40°C	3	0.55	42	90
Delicates 40°C	3	0.55	63	65
Wool/Handwash 30°C	2	0.25	55	60

1) «Cotton Energy Saving programme » at 60°C with a load of 7kg is the reference programme for the data entered in the energy label, in compliance with 96/60/EC Directive.

OPTIONS

SPIN

With this option you can change the default spin speed.

The indicator of the set speed comes on.

RINSE HOLD

- Set this option to prevent the laundry creases. The related indicator comes on.
- There is a water in the drum when the programme is completed.
- The drum turns regularly to prevent the laundry creases.
- The door stays locked. You must drain the water to unlock the door.



To drain the water refer to 'At the end of the programme'.

OPTION

Press this button to set one of the following options:

The related indicator comes on.

- **Eco**
Use this option if you want to wash laundry saving energy. The time is prolonged while the temperature is reduced. Only for cottons and synthetic items with normal or light soil at a temperature of 40°C or higher.

- **Quick Wash**

Press this button to decrease the programme duration.

Set this option for items with light soil or items to refresh.

EXTRA RINSE

With this option you can add some rinses to a washing programme.

Use this option for persons allergic to detergents and in areas where the water is soft.

The related phase indicator on the control panel comes on.

DRYING TIME

With this option you can set the time for the fabrics you have to dry (cottons or synthetics) . The display shows the set value.

Each time you press this button the time value increases by 5 minutes.

For Cottons you can set a drying time from 10 minutes to 250 minutes (4.10), for synthetics from 10 minutes to 130 minutes (2.10).



You cannot set all time values for different types of fabrics.

EASY IRON

The laundry is gently washed and spun to avoid any creasing. In this way ironing is easier.

Furthermore, the appliance will perform some additional rinses in some programmes.

On cotton programmes the maximum spin speed is reduced automatically.

DELAY START

With this option you can delay the start of a programme from 30 minutes to 20 hours. The display shows the related indicator.

SETTINGS

DOOR

With this option you can prevent that the children play with the control panel.

- To **activate/deactivate** this option, press Spin and Options at the same time until the indicator Door **comes on/goes off**.

You can activate this option:

- After you press Start/Pause: the options and the programme knob are locked.
- Before you press Start/Pause: the appliance cannot start.

BEFORE FIRST USE



During installation or before first use you may observe some water in the appliance. This is residual water left in the appliance after a full functional test in the factory to ensure the appliance is delivered to customers in perfect working order and is no cause for concern.

1. Connect the mains plug to the mains socket.
2. Open the water tap.

DAILY USE - WASHING ONLY



WARNING! Refer to Safety chapters.

LOADING THE LAUNDRY

Open the water tap. Connect the mains plug to the mains socket.

1. Pull the door handle to open the appliance door.
2. Put the laundry in the drum, one item at a time.
3. Shake the items before you put them in the appliance.

Make sure not to put too much laundry in the drum. Refer to max. loads indicated in "Programme chart".

DOOR LOCKED INDICATOR DOOR

The indicator Door shows when the door can be opened:

- The indicator is on: the door cannot be opened.
- The indicator flashes: the door is opening in some minutes.
- The indicator is off: the door can be opened.

ACOUSTIC SIGNALS

The acoustic signals operate when:

- The programme is completed.
- The appliance has a malfunction.

To **deactivate/activate** the acoustic signals, press Extra rinse and Drying Time at the same time for 6 seconds.



If you deactivate the acoustic signals, they continue to operate when the appliance has a malfunction.

3. Put 2 litre of water in the detergent compartment for washing phase.

This activates the drain system.

4. Put a small quantity of detergent in the compartment for washing phase.
5. Set and start a programme for cotton at the highest temperature without laundry.

This removes all possible dirt from the drum and the tub.

4. Close the door.

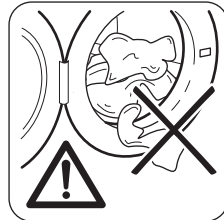



CAUTION! Make sure that no laundry stays between the seal and the door. There is a risk of water leakage or damage to the laundry.



Washing heavily oiled, greasy stains could cause damage rubber parts of the washing machine.

USING DETERGENT AND ADDITIVES

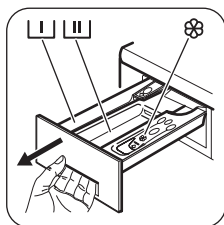

1. Measure out the detergent and the fabric conditioner.
2. Put the detergent and the fabric conditioner into the compartments.
3. Carefully close the detergent drawer.

DETERGENT COMPARTMENTS

	Detergent compartment for pre-wash phase.
	Detergent compartment for washing phase.
	Compartment for liquid additives (fabric conditioner, starch).

SETTING A PROGRAMME

1. Turn the programme knob to switch the appliance on and set the programme:
 - The indicator of the button **Start/Pause** flashes.
 - The display shows the programme duration.
2. If necessary, change the spin speed or add available options. When you activate an option, the indicator of the set option comes on.

To reset a programme or switch the machine off, turn the programme knob to position.



If you set something incorrect, the display shows the message

STARTING A PROGRAMME WITHOUT THE DELAY START

Press the button Start/Pause.

- The indicator of the button Start/Pause stops to flash and stays on.
- The programme starts, the door locks, the indicator Door is on.

- The programme time decreases with steps of one minute.



The drain pump can operate for a short time at the beginning of the washing cycle.

STARTING A PROGRAMME WITH THE DELAY START OPTION

1. Press the button Delay Start again and again until the display shows the delay you want to set. The delay start indicator comes on.
2. Press the button Start/Pause:
 - The door is locked and the indicator Door is on.
 - The appliance starts the countdown.
 - When the countdown is completed, the programme starts automatically.



You can cancel or change the set of the Delay Start option before you press the button Start/Pause. After pressing the button Start/Pause you can only cancel the Delay Start option.

To cancel the Delay Start option:

- a. Press the button Start/Pause to set the appliance to pause. The indicator of button Start/Pause flashes.
- b. Press the button Delay Start until the display shows .
Press the button Start/Pause again to start the programme immediately.

CANCELLING A RUNNING PROGRAMME

1. Turn the programme knob to position to cancel the programme and to deactivate the appliance.
2. Turn the programme knob again to activate the appliance. Now, you can set a new washing programme.



Before starting the new programme the appliance could drain the water. In this case, make sure that the detergent is still in the detergent compartment, if not fill the detergent again.

INTERRUPTING A PROGRAMME AND CHANGING THE OPTIONS

You can change only some options before they operate.

1. Press the button Start/Pause. The indicator flashes.
2. Change the options.

3. Press the button Start/Pause again.
The programme continues.

OPENING THE DOOR

While a programme or the Delay Start operates, the appliance door is locked. The indicator Door is on.





CAUTION! If the temperature and level of the water in the drum are too high and the drum still rotates, you cannot open the door.

To open the door during the first minutes of the cycle or when the Delay Start operates:

1. Press the button Start/Pause to pause the appliance.
2. Wait until the indicator Door goes off.
3. You can open the door.
4. Close the door and touch the button Start/Pause again. The programme (or the Delay Start) continues.

AT THE END OF THE PROGRAMME

- The appliance stops automatically.
- The acoustic signal operates (if it is activated).
- In the display  comes on.
- The indicator of the button Start/Pause goes off.
- The door lock indicator Door goes off.

Turn the programme knob to position  to deactivate the appliance.

- You can open the door.
- Remove the laundry from the appliance. Make sure that the drum is empty.
- Close the water tap.
- Keep the door and the detergent drawer ajar, to prevent the mildew and odours.

The washing programme is completed, but there is water in the drum:

- The drum turns regularly to prevent the creases in the laundry.
- The indicator Rinse Hold stays on to remind you to drain the water.
- The door lock indicator Door is on. The indicator of button Start/Pause flashes. The door stays locked.
- You must drain the water to open the door.

Draining the water:

1. To drain the water.
 - Set a Drain or a Spin programme.
 - Press the button Start/Pause. The appliance drains the water and spins.
2. When the programme is completed and the door lock indicator Door goes off, you can open the door.

3. Turn the programme knob to the position  to deactivate the appliance.

STAND BY

Some minutes after the end of the washing programme, if you do not deactivate the appliance, the energy saving status activates. The energy saving status decreases the energy consumption when the appliance is on the standby:

- All indicators and the display go off.
- The indicator of button Start flashes slowly.

Press one of the buttons to deactivate the energy saving status.

At the end of the programme

- The appliance stops automatically.
- The acoustic signal operates (if it is activated).
- In the display  comes on.
- The indicator of the button Start/Pause goes off.
- The door lock indicator Door goes off.

Turn the programme knob to position  to deactivate the appliance.

- You can open the door.
- Remove the laundry from the appliance. Make sure that the drum is empty.
- Close the water tap.
- Keep the door and the detergent drawer ajar, to prevent the mildew and odours.

The washing programme is completed, but there is water in the drum:

- The drum turns regularly to prevent the creases in the laundry.
- The indicator Rinse Hold stays on to remind you to drain the water.
- The door lock indicator Door is on. The indicator of button Start/Pause flashes. The door stays locked.
- You must drain the water to open the door.

Draining the water:

1. To drain the water.
 - Set a Drain or a Spin programme.
 - Press the button Start/Pause. The appliance drains the water and spins.
2. When the programme is completed and the door lock indicator Door goes off, you can open the door.
3. Turn the programme knob to the position  to deactivate the appliance.

DAILY USE - DRYING ONLY



WARNING! Refer to Safety chapters.



This appliance is an automatic washer dryer.

DRYING SETTING



The recommended load size is 4 kg for cottons and linen, and 2 kg for synthetic items.

1. Load the laundry one item at a time.
2. Turn the programme dial to the programme applicable for the items to dry (cottons or synthetics).



To have a good drying performance **do not** exceed the maximum drying loads recommended in the user manual. **Do not** set a spin speed lower than the automatic speed of the set programme.

TIMED DRYING

1. Press the button Drying Time again and again to set the time value (see the «Programmes for timed drying» table).
 - Each time you press this button the time value increases by 5 minutes.
 - As the appliance calculates also the duration of the anti-crease and the cooling phases, the programme time will automatically increase by some minutes.
2. Press Start/Pause button to start the programme.

DAILY USE - WASHING & DRYING



WARNING! Refer to Safety chapters.



This appliance is an automatic washer dryer.

NON-STOP PROGRAMME (AUTOMATIC WASHING & DRYING)

For NON-STOP programme the recommended load size is 4 kg for cotton and 2 kg for synthetic.

- The display shows regularly a new time value.
- The indicator Door is on.





If you set only 10 minutes of drying, the appliance performs only a cooling phase.

If the laundry is not sufficient dry, set again a short drying time.

END OF THE DRYING PROGRAMME

The appliance stops automatically.

- The acoustic signals operate (if they are active).
- In the display  comes on.
- The indicator of the Start/Pause button goes off.
- The last minutes of the drying cycle the appliance performs a cooling and anti-crease phase. The door is still locked. The display show a flashing .

When the door locked indicator Door goes off, you can open the door.

1. Turn the programme knob to  position to deactivate the appliance.

After some minutes from the end of the programme, the energy saving function automatically deactivates the appliance.

2. Remove the laundry from the appliance.

Make sure that the drum is empty.

3. Keep the door ajar, to prevent mildew and odours.
4. Close the water tap.



CAUTION! Do not use a dosing device/ball when carrying out a washing and drying programme.

1. Load the laundry one item at a time.
2. Put the detergent and the additives in the appropriate compartment.
3. Turn the programme knob to the required programme to switch the machine on.
4. Set the available options.



To have a good drying performance **do not** exceed the maximum drying loads recommended in the user manual. **Do not** set a spin speed lower than the automatic speed of the set programme.

WASHING & TIMED DRYING

To have a good drying the appliance does not let you set a too low spin speed for the items to be washed and dried.

1. Press the button Drying Time to set the drying time value.

After some seconds the display shows the final time value, that is the total duration of the washing and drying cycles (washing + drying + anti-crease + cooling phases).



If you set only 10 minutes of drying after washing, the appliance calculates also the duration of the anti-crease and the cooling phases.

2. Press Start/Pause button to start the programme.

The indicator Door comes on. The door is locked. The display shows regularly a new time value.

END OF THE PROGRAMME

The appliance stops automatically. The acoustic signals operate (if they are active).

HINTS AND TIPS

THE LAUNDRY LOAD

- Divide the laundry in: white, coloured, synthetics, delicates and wool.
- Obey the washing instructions that are on the laundry care labels.
- Do not wash white and coloured items together.
- Some coloured items can discolour with the first wash. We recommend that you wash them separately for the first times.
- Button up pillowcases, close zippers, hooks and poppers. Tie up belts.
- Empty the pockets and unfold the items.
- Turn multilayered fabrics, wool and items with painted illustrations inside out.
- Remove hard stains with a special detergent.
- Wash and pre-treat heavy soil stains before putting items in drum
- Be careful with the curtains. Remove the hooks and put the curtains in a washing bag or pillowcase.
- Do not wash laundry without hems or with cuts. Use a washing bag to wash small and/or

For more information see "At the end of the drying programme" of the previous chapter.

1. Turn the selector dial to the position  to switch the machine off.
2. Remove the laundry from the appliance. Make sure that the drum is empty.
3. Keep the door ajar, to prevent mildew and odours.
4. Close the water tap.

FLUFF IN THE FABRICS

During the washing and/or drying phase, some types of fabric, (sponge, sweatshirt) could release fluff.

The released fluff could stick to the fabrics during the next cycle.

This inconvenient increases with technical fabrics. To prevent the fluff in your laundry, we recommend that you:

- To do not wash dark fabrics after you washed and dried light coloured fabrics (new sponge, sweatshirt) and the contrary.
- To dry this type of fabrics at open air when they are washed the first time.
- To clean the drain filter.
- After the drying phase, clean the empty drum, the gasket and the door with a wet cloth.

delicate items (e.g. underwired bras, belts, tights, etc.).

- A very small load can cause balance problems with the spin phase. If this occurs, adjust manually the items in the tub and start the spin phase again.

STUBBORN STAINS

For some stains, water and detergent is not sufficient.

We recommend that you pre-treat these stains before you put the items in the appliance.

Special stain removers are available. Use the special stain remover that is applicable to the type of stain and fabric.

DETERGENTS AND ADDITIVES

- Only use detergents and additives specially made for washing machines:
 - powder detergents for all types of fabric,

- powder detergents for delicate fabrics (40 °C max) and woollens,
 - liquid detergents, preferably for low temperature wash programmes (60 °C max) for all types of fabric, or special for woollens only.
- Do not mix different types of detergents.
 - To help the environment, do not use more than the correct quantity of detergent.
 - Obey the instructions that you find on the on packaging of these products.
 - Use the correct products for the type and colour of the fabric, the programme temperature and the level of soil.
 - If your appliance does not have the detergent dispenser with the flap device, add the liquid detergents with a dosing ball (supplied by the detergent's manufacturer).

ECOLOGICAL HINTS

- Set a programme without the prewash phase to wash laundry with normal soil.
- Always start a washing programme with the maximum load of laundry allowed.
- If necessary, use a stain remover when you set a programme with a low temperature.
- To use the correct quantity of detergent, check the water hardness of your domestic system. Refer to "Water hardness".

WATER HARDNESS

If the water hardness in your area is high or moderate, we recommend that you use a water softener for washing machines. In areas where the water hardness is soft it is not necessary to use a water softener.

To know the water hardness in your area, contact your local water authority.

Use the correct quantity of the water softener. Obey the instructions that you find on the packaging of the product.

PREPARE THE DRYING CYCLE

- Open the water tap.
- Check if the drain hose is connected properly. Refer to installation chapter for more information.
- For the maximum laundry load of the drying programmes, refer to the drying programmes table.





ITEMS NOT SUITABLE FOR DRYING

Do not set a drying programme for this laundry:

- Synthetic curtains.
- Pieces of clothing with metal inserts.
- Nylon stockings.
- Quilts.
- Bed covers.
- Duvets.
- Anoraks.
- Sleeping bags.
- Fabrics with residue of hair sprays, nail solvents or similar.
- Garments with foam-rubber or materials similar to foam-rubber.

GARMENT LABELS

When you dry the laundry, obey the indications on the labels of the manufacturers:

-  = The item can be tumble dried
-  = The drying cycle is at high temperature
-  = The drying cycle is at reduced temperature
-  = The item can not be tumble dried.

DRYING CYCLE DURATION

The drying time can change depending on:

- speed of the last spin
- dryness level
- type of laundry
- weight of the load

ADDITIONAL DRYING

If, at the end of the drying programme, the laundry is still damp, set a short drying cycle again.



WARNING! To avoid creasing and shrinkage do not overdry the laundry.

GENERAL TIPS

Refer to the «Drying programmes» table to find the **average** drying times.

Experience will help you to dry the laundry better. Take note of the duration of the cycles done before.

To avoid the static charge at the end of the drying cycle:

1. Use fabric conditioner in the washing cycle.
2. Use special fabric conditioner for tumble dryers.

When the drying programme is completed remove the laundry promptly.

CARE AND CLEANING



WARNING! Refer to Safety chapters.

EXTERNAL CLEANING

Clean the appliance with soap and warm water only. Fully dry all the surfaces.



CAUTION! Do not use alcohol, solvents or chemical products.

DESCALING

If the water hardness in your area is high or moderate, we recommend that you use a water descaling product for washing machines.

Regularly examine the drum to prevent limescale and rust particles.

To remove rust particles use only special products for washing machines. Do this separately from the laundry wash.



Always obey the instructions that you find on the packaging of the product.

MAINTENANCE WASH

With the low temperature programmes it is possible that some detergent stays in the drum. Perform a maintenance wash regularly. To do this:

- Remove all laundry from the drum.
- Select the cotton programme with the highest temperature with a small quantity of detergent.

DOOR SEAL

This appliance is designed with a **self cleaning draining system**, allowing light fluff fibers that fall off the clothes to be drained out with the water, in such a way that there is no need to access this area for regular maintenance and cleaning.

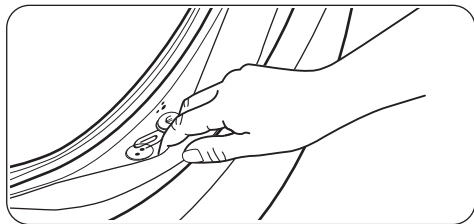

Regularly examine the seal and remove all objects from the inner part. Coins, buttons, other small items forgotten in the pockets of your clothes are deposited during the washing cycle in the special

double lip trap in the porthole seal, where they can be conveniently recovered at the end of the cycle.

CLEANING THE DETERGENT DISPENSER

Clean regularly the washing powder and additive dispenser drawer.

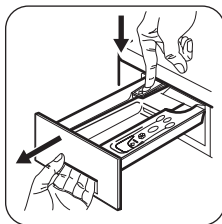

- Press the catch downwards and pull it out to remove the drawer.
- Flush it out under a tap, to remove any traces of accumulated powder.

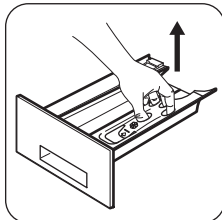

- Remove the top part of the additive compartment to aid cleaning.

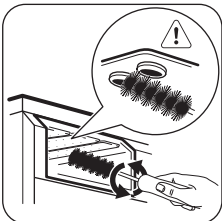

- Make sure that all washing powder residue is removed from the upper and lower part of the recess.
- Use a small brush to clean the recess.

- Replace the drawer and run the rinse programme without any clothes in the drum.

CLEANING THE DRAIN FILTER

The pump should be inspected regularly and particularly if:

- the appliance does not empty and/or spin;
- the appliance makes an unusual noise during draining phase due to objects such as safety pins, coins and so on blocking the pump;
- a problem with water draining is detected (see chapter 'Troubleshooting' for more details).



CAUTION! Switch the appliance off and remove the mains plug from the socket.

Proceed as follows:

- Unplug the appliance.
- If it is necessary, wait until the water has cooled down.

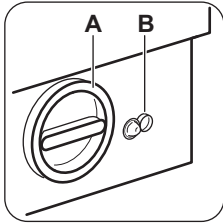

- Place a container close to the pump (A) to collect any spillage.
- Pull out the emergency emptying hose (B), place it in the container and remove its cap.

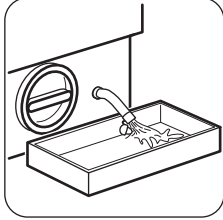

- When no more water comes out, unscrew the filter.
- Turn the filter anti-clockwise.

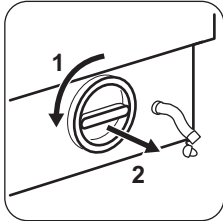

- Remove the filter.
- Use pliers, if necessary.
- When removing the filter, always keep a rag nearby to dry up any water spillage.
- Clean the filter under a tap, to remove any traces of fluff.

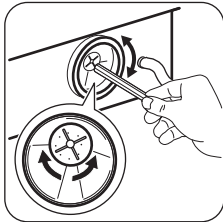

- Remove foreign bodies and fluff from the filter seat and from the pump impeller.
- Check carefully whether the pump impeller rotates (it rotates jerkily).

If it doesn't rotate, please contact your Service Centre.

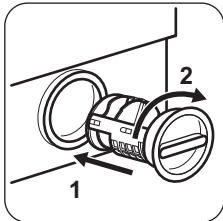

- Put the cap back on the emergency emptying hose and place the latter back in its seat.
- Replace the filter into the pump, insert it correctly into the special guides.

- Screw the pump cover firmly. Turn it clockwise.



CAUTION! When the appliance is in use and depending on the set programme there can be hot water in the pump.

Never remove the filter during a washing cycle, always wait until the appliance has finished the cycle, and is empty.

When refitting the filter, ensure it is securely re-tightened so as to stop leaks and young children being able to remove it.

CLEANING THE INLET HOSE AND THE VALVE FILTER

If the appliance doesn't fill, take long to fill with water, the starting button blinks or the display (if available) shows the relevant alarm (see chapter 'Troubleshooting' for more details), check if the water inlet filters are blocked.

To clean the water inlet filters:

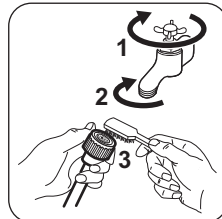

- Turn off the water tap.
- Unscrew the hose from the tap.
- Clean the filter in the hose with a stiff brush.

- Screw the hose back onto the tap. Make sure the connection is tight.



- Unscrew the hose from the machine.
- Keep a rag nearby because some water may flow.

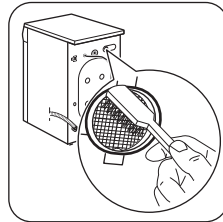

- Clean the filter in the valve with a stiff brush or with the piece of cloth.

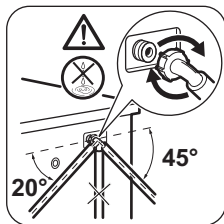

- Screw the hose back to the machine and make sure the connection is tight.
- Turn on the water tap.



WARNING! Make sure that the temperature is more than 0 °C before you use the appliance again. The manufacturer is not responsible for damages caused by low temperatures.

FROST PRECAUTIONS

If the appliance is installed in an area where the temperature can be less than 0° C, remove the remaining water from the inlet hose and the drain pump.

1. Disconnect the mains plug from the mains socket.
2. Close the water tap.
3. Place the end of the emergency emptying hose and that of the inlet hose in a bowl placed on the floor and let water flow out of the hoses.
4. Set the Drain programme and let it operate until the end of the cycle.
5. Turn the programme knob to  to disconnect the appliance from the power supply.
6. Screw the water inlet hose back on and re-fit the emergency emptying hose after having put the cap on again.

EMERGENCY EMPTYING OUT

If the appliance does not drain the water, proceed as follows:

1. Disconnect the mains plug from the mains socket.
2. Close the water tap.
3. If necessary, wait until the water has cooled down.
4. Place a bowl on the floor and put the end of the emergency emptying hose into the bowl. Remove its cap.

The water should drain by gravity into the bowl.

5. When the bowl is full, put the cap back on the emergency hose.
6. Empty the bowl. Repeat the procedure until water stops flowing out.
7. Clean the pump if necessary as previously described.
8. Replace the emergency emptying hose in its seat after having plugged it.
9. Screw the water inlet hose back on.

TROUBLESHOOTING



WARNING! Refer to Safety chapters.

INTRODUCTION

The appliance does not start or it stops during operation.

First try to find a solution to the problem (refer to the table). If the problem persists, contact the Authorised Service Centre.

With some problems, the acoustic signals operate and the display shows an alarm code:

- **E10** - The appliance does not fill with water properly. Start the appliance again by pressing Start/Pause button. After 10 seconds the door will be unlocked.

- **E20** - The appliance does not drain the water.
- **E40** - The appliance door is open or not closed correctly. Please check the door!
- **E40** - The mains supply is unstable. Wait until the mains supply is stable.
- **E91** - No communication between electronic elements of the appliance. Switch off and switch on again. The programme was not finished properly or the appliance stopped too early. If the alarm code appears again, contact the Authorised Service Centre.



WARNING! Deactivate the appliance before you do the checks.

POSSIBLE FAILURES

Problem	Possible solution
The programme does not start.	<ul style="list-style-type: none"> ▪ Make sure that the mains plug is connected to the mains socket. ▪ Make sure that the appliance door is closed. ▪ Make sure that there is not a damaged fuse in the fuse box. ▪ Make sure that the Start/Pause has been pressed. ▪ If the delay start is set, cancel the setting or wait for the end of countdown. ▪ Deactivate the Child Lock function if it is on (if available).
The appliance does not fill with water properly.	<ul style="list-style-type: none"> ▪ Make sure that the water tap is open. ▪ Make sure that the pressure of the water supply is not too low. For this information, contact your local water authority. ▪ Make sure that the water tap is not clogged. ▪ Make sure that the filter of the inlet hose and the filter of the valve are not clogged. Refer to "Care and cleaning". ▪ Make sure that the inlet hose has no kinks or bends. ▪ Make sure that the connection of the water inlet hose is correct.
The appliance does not drain the water.	<ul style="list-style-type: none"> ▪ Make sure that the sink spigot is not clogged. ▪ Make sure that the drain hose has no kinks or bends. ▪ Make sure that the drain filter is not clogged. Clean the filter, if necessary. Refer to 'Care and cleaning'. ▪ Make sure that the drain hose is in the correct position. The hose may be too low. ▪ Set the drain programme if you set a programme without drain phase. ▪ Set the drain programme if you set an option which ends with water in the tub.
The spin phase does not operate or the washing cycle lasts longer than usually.	<ul style="list-style-type: none"> ▪ Set the spin programme. ▪ Adjust manually the items in the tub and start the spin phase again. This problem may be caused by balance problems.
There is water on the floor.	<ul style="list-style-type: none"> ▪ Make sure that the couplings of the water hoses are tight and there is not water leakages. ▪ Make sure that the drain hose have no damages. ▪ Make sure you use the correct detergent and the correct quantity of it. ▪ Make sure you have replaced the emergency emptying cap into the filter ▪ Make sure you have properly screwed the filter in after cleaning.
You cannot open the appliance door.	<ul style="list-style-type: none"> ▪ Make sure that the washing programme is finished. ▪ Set the drain or the spin programme if there is water in the drum.
The appliance makes an unusual noise.	<ul style="list-style-type: none"> ▪ Make sure the levelling of the appliance is correct. Refer to 'Installation'. ▪ Make sure that the packaging and/or the transit bolts are removed. Refer to 'Installation'. ▪ Add more laundry in the drum. The load may be too small.

Problem	Possible solution
The washing results are not satisfactory.	<ul style="list-style-type: none"> ▪ Increase the detergent quantity or use a different detergent. ▪ Use special products to remove the stubborn stains before you wash the laundry. ▪ Make sure that you set the correct temperature. ▪ Decrease the laundry load.
You cannot set an option.	<ul style="list-style-type: none"> ▪ Make sure that you press only the wanted button(s).
The machine does not dry or does not dry properly:	<ul style="list-style-type: none"> ▪ Make sure that you have set a suitable drying programme for your laundry. ▪ Make sure that you set the correct the drying time or dryness degree. ▪ Make sure that the water tap is not turned on. ▪ the drain filter is not clogged. ▪ Make sure you have not overloaded the appliance.
The laundry is full of different coloured fluff:	<p>The fabrics washed in the previous cycle released fluff of a different colour.</p> <ul style="list-style-type: none"> ▪ Clean the clothes with a fluff remover ▪ The drying phase helps to eliminate some fluff. <p>In case of an excessive amount of fluff in the drum, refer to section «FLUFF IN THE FABRICS».</p> <ul style="list-style-type: none"> ▪ Thoroughly clean the empty drum, the gasket and the door with a wet rag. ▪ Perform a rinse cycle. ▪ Put a wool or piled fabric rag inside the drum. ▪ Perform a drying cycle of 10 minutes. ▪ Remove the old wool cloth. <p>Now you can wash other garments.</p>

After the check, activate the appliance. The programme continues from the point of interruption. If the problem occurs again, contact the Authorised Service Centre.

If the display shows other alarm codes. Deactivate and activate the appliance. If the problem continues, contact the Service.

SERVICE

We recommend the use of original spare parts. When contacting the Authorised Service Centre, make sure that these data are available. You can find the information on the rating plate: model, PNC and Serial Number. (Mod., Prod. No., Ser. No.)

INSTALLATION



WARNING! Refer to Safety chapters.

UNPACKING



Remove all transit bolts and packing before you use the appliance. You are advised to keep all transit devices so that they can be refitted if the appliance ever has to be transported again.

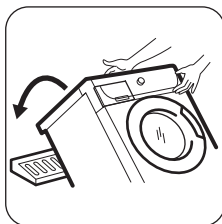

- After removing all the packaging, carefully lay the appliance on its back to remove the polystyrene base from the bottom.

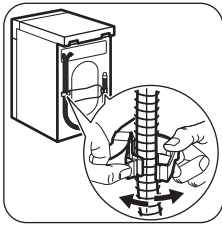

- Remove the power supply cable and the draining hose from the hose holders on the rear of the appliance.

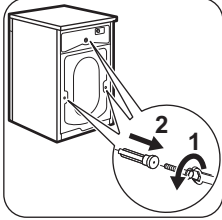

- Unscrew the three bolts.

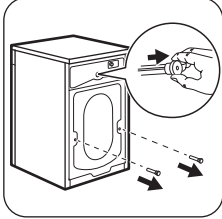

- Slide out the relevant plastic spacers.



- Remove the polystyrene block fitted on the door seal. Pull out all items from the drum.

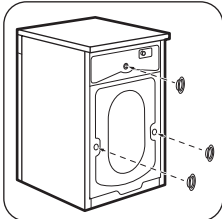

- Fill the smaller upper hole and the two large ones with the plastic plug caps supplied in the bag with the User Manual.

POSITIONING

- Install the machine on a flat hard floor. Make sure that air circulation around the appliance is not impeded by carpets, rugs etc.
- Check that the machine does not touch the wall or other kitchen units.

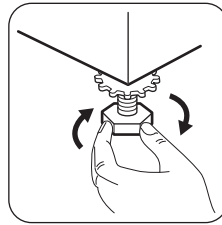

- Level the appliance by raising or lowering the feet.
- The feet may be tight to adjust as they incorporate a self locking nut, but the appliance **MUST** be level and stable.

- If necessary, check the setting with a spirit level. Any necessary adjustment can be made with a spanner.

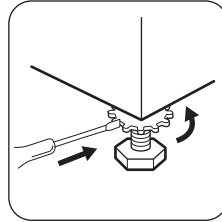

- After having levelled the appliance, tighten the lock nuts.
- Accurate levelling prevents vibration, noise and displacement of the appliance during operation.



Never place cardboard, wood or similar materials under the appliance to compensate for any unevenness in the floor.

WATER INLET

- The inlet hose is supplied with the appliance and can be found inside the appliance drum.
- Do not use the hose from your previous appliance to connect to the water supply.



This appliance must be connected to a cold water supply.

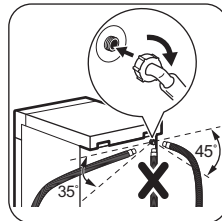

- Connect the hose with the angled connection to the machine. Do not place the inlet hose downwards.
- Angle the hose to the left or right depending on the position of your water tap.
- Set the hose correctly by loosening the ring nut. After positioning the inlet hose, be sure to tighten the ring nut again to prevent leaks.

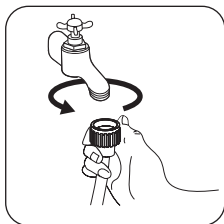

- Connect the hose to a tap with a 3/4" thread. Always use the hose supplied with the appliance.

- The inlet hose must not be lengthened. If it is too short and you do not wish to move the tap, you will have to purchase a new, longer hose specially designed for this type of use.

WATER DRAINAGE

The end of the drain hose can be positioned in three ways:



- **Hooked over the edge of a sink using the plastic hose guide supplied with the machine.**

In this case, make sure the end cannot come unhooked when the appliance is emptying. This could be done by tying it to the tap with a piece of string or attaching it to the wall.

- **In a sink drain pipe branch.**

This branch must be above the trap so that the bend is at least 60 cm above the ground.

- **Directly into a drain pipe** at a height of not less than 60 cm and not more than 90 cm.

The end of the drain hose must always be ventilated, i.e. the inside diameter of the drainpipe must be larger than the outside diameter of the drain hose. The drain hose must not be kinked.

The drain hose may be extended to a maximum of 4 metres. An additional drain hose and joining piece is available from your local Service Centre

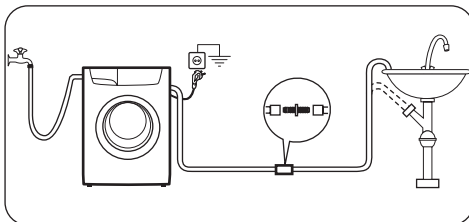

BUILDING IN

OVERVIEW

This appliance has been designed to be built into the kitchen furniture. The recess should have the dimensions shown in the picture below:

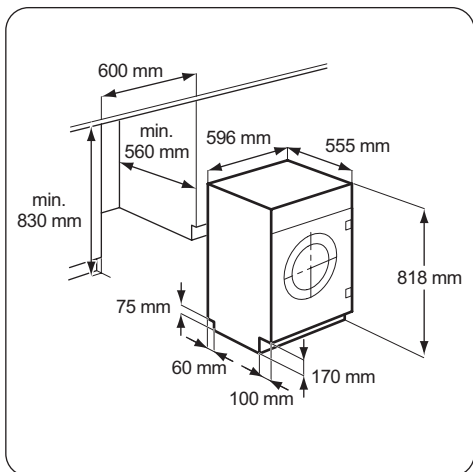

i We recommend that you keep the packaging and the transit bolts for any movement of the appliance.

Installing anti-tilting device

i If the height of the counter is 820 mm or lower, you **cannot** install the anti-tilting device.

Remove the screws of the top cover on the rear of the appliance and install the anti-tilting device as shown in the drawing.

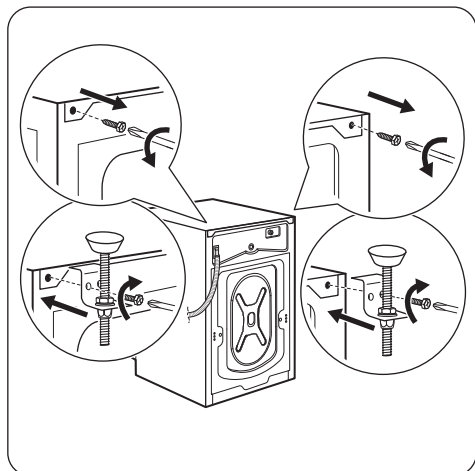

Adjust the anti-tilting device so that the distance from the counter is 10mm. Loosen the nut

counterclockwise with a 3mm wrench. Adjust the height and turn the nut clockwise to fix it.

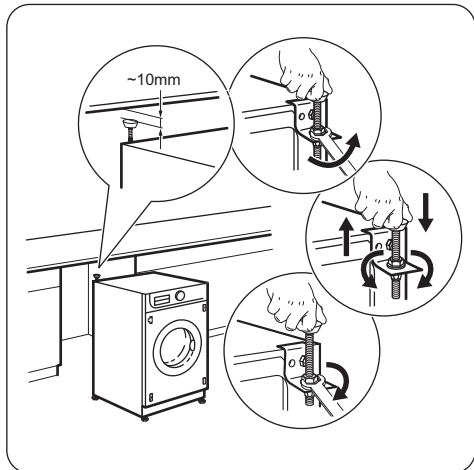

PREPARATION AND ASSEMBLY OF THE DOOR

The appliance is originally prearranged for the assembly of a door opening from right to left (see picture below)

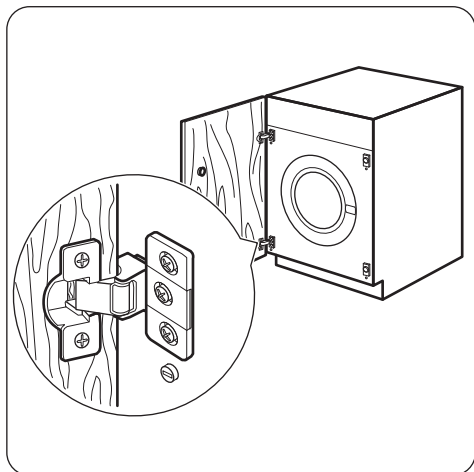

Door

- - width 595-598 mm
- - thickness 16-22 mm

The height X depends on the height of the adjacent furniture's base.

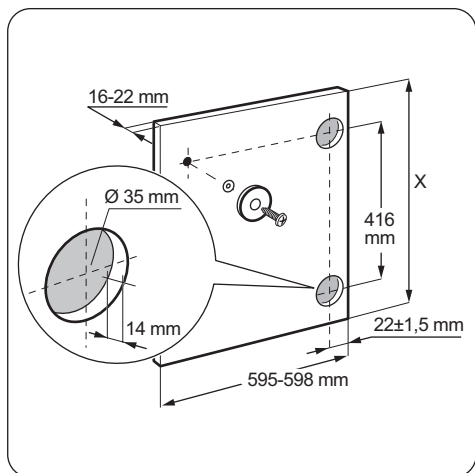

Hinges

To mount the hinges drill two holes (dia. 35 mm, depth 12.5-14 mm depending on the depth of door furniture) on the inner side of the door.

To fix the hinges to the door use the screws for wood **1** and **2** supplied with the appliance (see below).

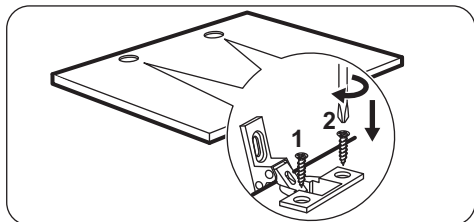

The distance between the holes hobs fixing centres must be 416 mm. The distance from upper edge of the door to the centre of the hole depends on the adjacent furniture's dimensions.

Door mounting

To mount the door fix the hinges to the appliance using the M5x15 screws.

i Do not remove the screw **B** !!

The hinges can be adjusted to compensate for possible uneven thickness of the door.

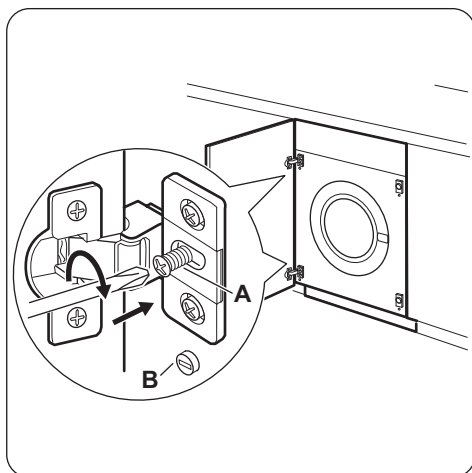

To align the door perfectly, loosen the screw, adjust the door and tighten the screw **A** again.

The appliance is prearranged for a magnetic closure of the door. To enable a correct operation of this device, screw the counter-magnet **A** (steel disk + rubber ring) into the inner side of the door. Its position must correspond to the magnet **B** on the appliance.

i Do not remove the screw **C** !

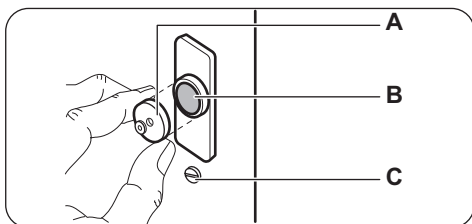

If the door has to be opened from left to right, invert the position of the plates **E**, the magnet **D** and the plate **C**.

Mount the counter-magnet **D** and the hinges **A** as previously described.

i Do not remove the screw **B** !

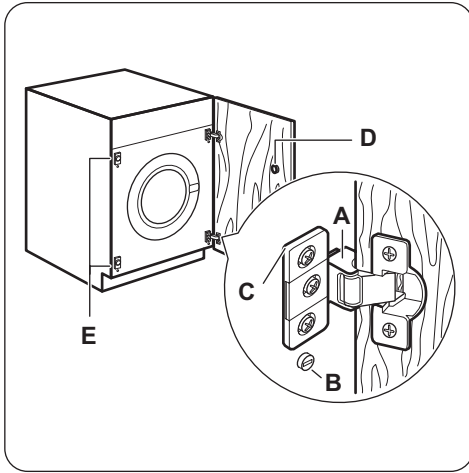

TECHNICAL DATA

Dimension	Width/ Height/ Depth/ Total depth	596 mm/ 818 mm/ 544 mm/ 560 mm
Electrical connection	Voltage Overall power Fuse Frequency	230-240 V 2050 W 13 A 50 Hz
Level of protection against ingress of solid particles and moisture ensured by the protective cover, except where the low voltage equipment has no protection against moisture		IPX4
Water supply ¹⁾		Cold water
Water supply pressure ²⁾	Minimum Maximum	0.5 bar (0.05 MPa) 8 bar (0.8 MPa)
Maximum wash load	Cotton	7 kg
Maximum dry load	Cotton Synthetics	4 kg 2 kg
Spin Speed	Maximum spin speed	1150 rpm

1) Connect the water inlet hose to a water tap with a 3/4" thread.

2) The appliance works correctly if the water pressure is not lower than 0.05 MPa (0.5 bar). If you cannot connect the water inlet hose to the cold water tap of the primary hydraulic system, connect it to your domestic cold water storage system. Make sure not to exceed a distance of 5.02 m (16.5 ft) between the appliance inlet hose and the bottom of the water storage tank.

ENVIRONMENTAL CONCERNS

Recycle materials with the symbol . Put the packaging in relevant containers to recycle it. Help protect the environment and human health by recycling waste of electrical and electronic appliances. Do not dispose of appliances marked

with the symbol  with the household waste. Return the product to your local recycling facility or contact your municipal office.

WWW.ZANUSSI.COM/SHOP



CE

157024930-A-392018